



# Think LivestockK



## VETERINARY PRODUCTS

- Injectors
- Drenchers
- Pour On Applicators
- Single-use and reusable needles
- Single-use and reusable syringes

 (03) 5448 8942

 [www.thinklivestock.com](http://www.thinklivestock.com)



# Table of Contents

---

## Injector

• HSW ECO-MATIC <sup>®</sup> with Bottle Mount Basket.....	Page 1
• HSW ECO-MATIC <sup>®</sup> with Bottle Mount Universal Collars.....	Page 2
• HSW ECO-MATIC <sup>®</sup> tubing version.....	Page 3
• HSW ECO-MATIC <sup>®</sup> Twin.....	Page 4
• HSW ECO-MATIC <sup>®</sup> Accessories.....	Page 5
• HSW Bottle holder .....	Page 6
• HSW ROUX-REVOLVER <sup>®</sup> .....	Page 7
• HSW MULTI-MATIC <sup>®</sup> .....	Page 8
• HSW VET-MATIC <sup>®</sup> .....	Page 9
• HSW FERRO-MATIC <sup>®</sup> .....	Page 10
• HSW SAFE-MATIC <sup>®</sup> .....	Page 11
• HSW UNI-MATIC <sup>®</sup> .....	Page 12
• HSW HENKE-JECT <sup>®</sup> TBC.....	Page 13
• HSW MICRO-MATIC <sup>®</sup> .....	Page 14
• TU FLEX-MASTER .....	Page 15
• HSW Accessories / Extensions .....	Page 16
• HSW Injection Bar .....	Page 18

## Drenchers

• HSW ECO-MATIC <sup>®</sup> Drencher .....	Page 20
• HSW DRENCH-MATIC <sup>®</sup> .....	Page 21
• HSW ECO-MATIC <sup>®</sup> with threaded bottle adapter.....	Page 22
• TU FLEX-MASTER.....	Page 23
• HSW Accessories / Nozzles .....	Page 24

## Pour On Applicators

• HSW ECO-MATIC <sup>®</sup> Pour On .....	Page 26
• HSW DRENCH-MATIC <sup>®</sup> .....	Page 27
• HSW Accessories / Nozzles .....	Page 28

## Reusable veterinary needles

• HSW-ECO <sup>®</sup> .....	Page 30
• HSW-PREMIUM <sup>®</sup> .....	Page 31

## Single-use needles

• HSW HENKE-JECT <sup>®</sup> .....	Page 32
-------------------------------------	---------

## Single-use syringes

• HSW HENKE-JECT <sup>®</sup> .....	Page 33
• HSW HENKE-JECT <sup>®</sup> Insulin syringes .....	Page 34

<b>Selection Guide</b> .....	Page 35
------------------------------	---------

# HSW ECO-MATIC®

0,3 ml / 0,5 ml / 1 ml / 2 ml / 5 ml

Automatic self-filling syringe for injections with Bottle Mount Basket

- Premium-quality plastic syringe with durable plastic barrel
- Durable metal needle fitting
- Accurate, continuously variable dose setting
- Exceptional in price and performance
- Ergonomic, compact design for ease of use
- Durable plastic basket in two sizes, ensuring
  - secure attachment of medication bottle
  - bottle protected against shock or impact
  - medication bottles can be changed quickly and easily (50 ml to 250 ml)



<p><b>Included in delivery</b></p> <p>HSW ECO MATIC® complete: 1 x Syringe with bottle attachment</p>				
<p><b>Version</b></p> <p>Luer Lock</p>	<p><b>Vol/ml</b></p> <p>0,3 ml (0,1 ml - 0,3 ml) 0,5 ml (0,1 ml - 0,5 ml) 1 ml (0,1 ml - 1,0 ml) 2 ml (0,2 ml - 2,0 ml) 5 ml (0,5 ml - 5,0 ml)</p>	<p><b>Item no.</b></p> <p>8300002189 8300034316 8300007181 3602130110 3605130110</p>		

# HSW ECO-MATIC®

0,3 ml / 0,5 ml / 1 ml / 2 ml / 5 ml

Automatic self-filling syringe for injections with Bottle Mount Universal Collars

- Color coded bottle collars for easy reference and identification of the right adapters for the different sized bottles
- Easy use, durable design, safe and secured bottle fitting
- For use with all medication bottles of different sizes and shapes (10, 50, 100, 200, 250 or 500 ml and larger) depending on the collar used: white Ø 20 mm, blue Ø 30 mm, green Ø 33 mm



## Included in delivery

HSW ECO-MATIC® complete:

- 1 x Syringe
- 1 x bottle collar Ø 20 mm
- 1 x bottle collar Ø 30 mm
- 1 x bottle collar Ø 33 mm



## Version

## Vol/ml

## Item no.

Luer Lock

0,3 ml (0,1 ml - 0,3 ml)  
0,5 ml (0,1 ml - 0,5 ml)  
1 ml (0,1 ml - 1,0 ml)  
2 ml (0,2 ml - 2,0 ml)  
5 ml (0,5 ml - 5,0 ml)

8300026241  
8300037027  
8300026242  
8300026243  
8300026244





# HSW ECO-MATIC®

1 ml / 2 ml / 5 ml / 12,5 ml

Automatic self-filling syringe for injections in tubing version

- Premium-quality plastic syringe with durable plastic barrel
- Durable metal needle fitting
- Accurate, continuously variable dose setting
- 12.5 ml version: Dosing wheel for setting the required dosage
- Exceptional in price and performance
- Ergonomic, compact design for ease of use



## Included in delivery

HSW ECO-MATIC® complete:  
1 x Syringe with tubing



12,5 ml

## Version

Luer Lock

## Vol/ml

1 ml (0,1 ml - 1,0 ml)  
2 ml (0,2 ml - 2,0 ml)  
5 ml (0,5 ml - 5,0 ml)  
12,5 ml (0,5 ml - 12,5 ml)

## Item no.

8300007184  
3602130100  
3605130100  
8300022448

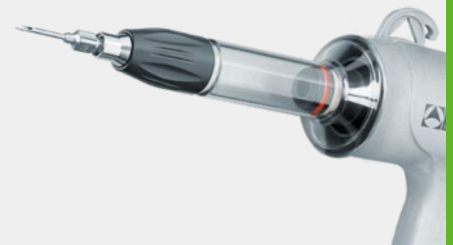

# HSW ECO-MATIC® TWIN

0,5 ml / 1 ml / 2 ml

Automatic self-filling syringe with two separate barrels

- Premium-quality plastic syringe with durable plastic barrels
- Ergonomic, light weight design for ease of use
- Simultaneous vaccination of two products independently
- Bottle mount and/or tubing connection
- Easy adjustable needle distance
- Easy adjustable barrel position
- Various fixed dose barrel combinations available



## Included in delivery

HSW ECO-MATIC® TWIN complete:  
 1 x Syringe  
 2 x Universal bottle collars Ø 20 mm  
 2 x Universal bottle collars Ø 30 mm  
 2 x Tubing collars (Ø 4-6 mm)  
 2 x PVC tubing (Ø 4 mm)

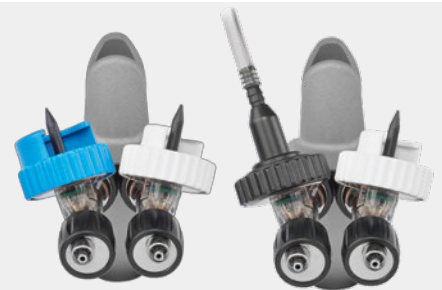

Version	Vol/ml	Item no.
Luer Lock	0,5 ml + 0,5 ml	8300037936
	0,5 ml + 2ml	8300031731
	1 ml + 1ml	8300037673
	2 ml + 2ml	8300037669
	1 ml + 2ml	8300037671

Further size combinations incl. 0.3 ml, 4 ml and 5 ml are available upon request.

The needle distance can be adapted to the age, size and species of the animal. There are seven different distances:  
 20 mm – 21,1 mm – 24 mm – 28 mm – 32 mm – 34,9 mm – 36 mm



# HSW ECO-MATIC® Accessories

Version		Item no.	
Plastic barrel (amber version):			
<ul style="list-style-type: none"> <li>barrel protects medication against UV light</li> <li>biocompatible and high resistance to medication</li> <li>absolutely break-proof</li> </ul>			
Luer Lock (amber barrel)	0,3 ml 1 ml 2 ml 5 ml	8300004068 8300007369 3602130002 3602130002	
Standard basket for medical bottles up to 100 ml* Special basket for medical bottles up to 250 ml*		81402799 8300013288	
*further details see page 21			
Autoclavable plastic barrel (amber version):			
<ul style="list-style-type: none"> <li>barrel protects medication against UV light</li> <li>autoclavable at up to 134°C/273°F</li> <li>biocompatible and high resistance to medication</li> <li>absolutely break-proof</li> </ul>			
Luer Lock (amber barrel)	1 ml 2 ml 5 ml	8300007368 3602030001 3605030001	
Draw-off caps	Ø20 mm white Ø30 mm blue Ø33 mm green	3600000020 3600000030 3600000033	
Set	<u>Ø20, 30, 33 mm</u>	<u>3600203033</u>	
Ascending tube	11 cm 18 cm 21,5 cm	3011760000 3018760000 3021760000	

# HSW Bottle Holders

Bottle holders made of Neoprene

- To fit and protect medicine and vaccine bottles
- To prevent or reduce vaccine temperature fluctuations
- To protect glass bottle from outside impact
- To protect vaccine from harmful UV lights
- Easy and comfortable use during injection process



Arm model for 50-100 ml vaccine bottles

The new HSW bottle holders are available in different models and sizes:

Arm model for 50-100 ml vaccine bottles	8300027748
Arm model for 250 ml vaccine bottles	8300027749
Arm model for 500-1000 ml vaccine bottles	8300027747
Belt/hanging model* for 50-100 ml vaccine bottles	8300027746
Belt/hanging model* for 250 ml vaccine bottles	8300027750
Belt/hanging model* for 500-1000 ml vaccine bottles	8300027751



All parts (side, bottom, needle holder etc.) sewed not glued

\*Belt/hanging model can be used on belt as shown or hanging around neck/shoulder



# HSW ROUX-REVOLVER®

10 ml / 30 ml / 50 ml

Repeater syringe for multiple dosing of live stock

- Metal/glass version
- Tensible piston
- Whole syringe can be dismantled
- Easy dosing adjustment by dosing wheel
- High quality for long service life
- A design which has been proven for decades



Included in delivery

HSW ROUX-REVOLVER® complete:

1 x Metal pistol

Dosage 1 ml – 5 ml (in 1 ml steps)

Version	Vol/ml	Item no.
Luer Lock	30 ml	3030030072
	50 ml	3050030072
Dosage 0,5 ml – 2,5 ml (in 0,5 ml steps)		

Luer Lock	30 ml	3030030080
Dosage 0,25 ml, 0,5 ml, 1 ml /		

Luer Lock	10 ml	3010030072
-----------	-------	------------

Fixed extension for 30 ml version	57 cm	3099000238
Fixed extension for 50 ml version	63 cm	3099000239
Flexible extension for all versions		
Luer Lock – Luer Lock	29 cm	3099000030

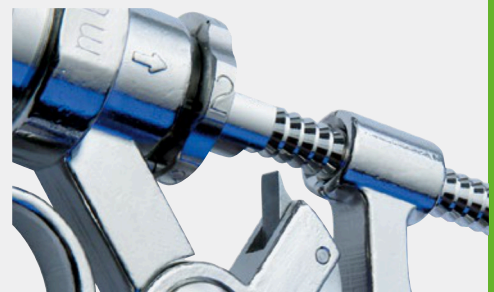



# HSW MULTI-MATIC®

25 ml / 50 ml

Repeater syringe for multiple dosing of live stock

- Durable pressure-cast aluminium handle
  - exceptional durability, yet lightweight
- Durable medical grade plastic barrel
  - with metal needle fitting
  - biocompatible – autoclavable (134°C/ 273°F)
  - chemically resistant to all known medication
  - UV-resistant and break-proof
- Exceptionally accurate dosing
  - tolerance < 1%
- Easy dose setting
  - via 0,5ml (25 ml) or 1ml (50 ml) dosage wheel
- Streamlined design
  - few spare parts required
- Ergonomic design for ease of use



## Included in delivery

HSW MULTI-MATIC® complete:  
1 x Syringe

## Version

## Vol/ml

## Item no.

Luer Lock

25 ml  
50 ml

3625030051  
3650030051

# HSW VET-MATIC®

5 ml / 10 ml

Automatic self-filling syringe for injections

- Metal/glass version
- Durable piston rod
- Easy to assemble/dismantle for servicing
- Accurate, continuously variable dose setting
- High quality for long service life



### Included in delivery

HSW VET-MATIC® complete:

- 1 x Syringe
- 1 x Ascending tube
- 1 x Tubing



### Version

Luer Lock

### Vol/ml

5 ml  
10 ml

### Item no.

3005030489  
3010030489



### Accessories

Ascending tube

11 cm  
18 cm  
21,5 cm

### Item no.

3011760000  
3018760000  
3021760000

Nozzle for use as „mini-drencher“

Luer Lock

11,4 cm

3600095605





# HSW FERRO-MATIC®

3 ml / 5 ml

Automatic self-filling syringe for injections

- Metal/glass version
- Durable piston rod
- Easy to assemble/dismantle for servicing
- Accurate, continuously adjustable dose setting
- Universal bottle collar Ø 20 mm and Ø 30 mm
- Bottle adapter interchangeable with HSW Uni-Matic®
- High quality for long service life



## Included in delivery

HSW FERRO-MATIC® complete:

1 x Syringe

1 x Universal bottle collar Ø 20 mm

1 x Universal bottle collar Ø 30 mm

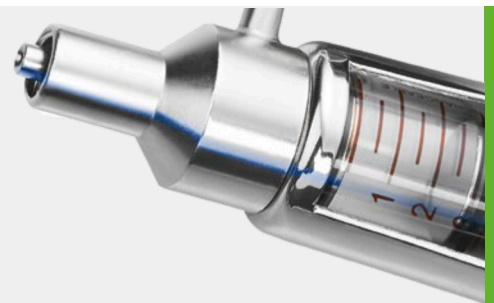

## Version

## Vol/ml

Luer Lock

3 ml

5 ml

## Item no.

3003030470

3005030470

## Accessories

Metal bottle adapter for glass bottles/

## Item no.

3000000471



# HSW SAFE-MATIC®

2 ml

Automatic self-filling syringe for injections with safety features

- 3 step safety mechanism to avoid accidental self-injections
- Most suitable for medicines which could be harmful for the user
- Syringe can be used universally with bottle adapter or tubing attachment
- Medication bottles can be replaced quickly and easily (50 ml and 100 ml)
- Durable and precise metal piston
- Dosing fixed at 2ml (not adjustable)

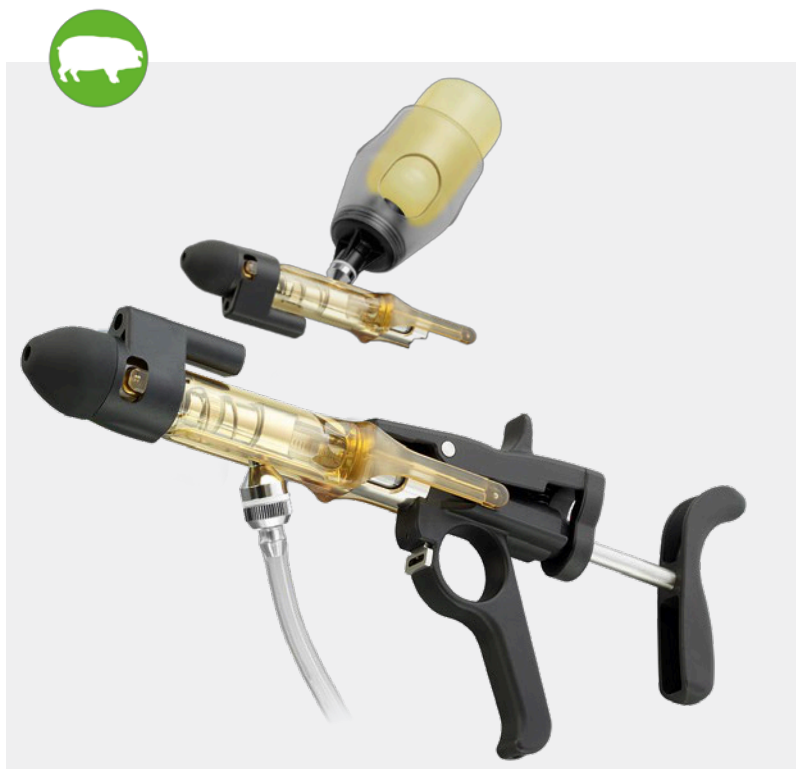

Included in delivery

HSW SAFE-MATIC® complete:

1 x Syringe

1 x Ascending tube 18 cm

1 x Tubing

Version

Vol/ml

Item no.

Luer Lock

2 ml

8300006508

The bottle adapter can be ordered separately.



# HSW UNI-MATIC®

1 ml / 2 ml / 5 ml

Automatic self-filling syringe for injections

- Syringe can be used universally with bottle adapter or tubing attachment
- With pin lock system: Bottle holder or tubing attachment can be positioned as required
- Durable and precise metal piston
- Innovative, ergonomic design provides fatigue-free function
- Medication bottles can be replaced quickly and easily (50 ml and 100 ml) with new bottle adapter
- Exceptionally accurate dosing



## Included in delivery (Tubing version)

HSW UNI-MATIC® complete:  
1 x Syringe  
1 x Ascending tube 18 cm  
1 x Tubing

Version	Vol/ml	Item no.
Luer Lock, Tubing	1 ml	3001330000
	2 ml	3002330000
	5 ml	8300003174



## Included in delivery (Bottle Mount Basket)

HSW UNI-MATIC® complete:  
1x Syringe  
1x Standard basket

Version	Vol/ml	Item no.
Luer Lock, bottle mount	1 ml	3001330471
	2 ml	3002330471
	5 ml	8300009763



## Accessories

Plastic adapter for glass bottles (standard version)  
- standard basket for medical bottles up to 100 ml

Item no.
8300011133
81402799

Metal bottle adapter for glass bottles (special version)/

3000000471

Ascending tube	11 cm	3011760000
	18 cm	3018760000
	21,5 cm	3021760000

The bottle adapter can be ordered separately.

# HSW HENKE-JECT® TBC

2 ml

Dosage syringe for tuberculin testing

- Fully visible glass barrel for visual verification
- Ergonomic light weight metal, plastic design
- 2 ml barrel with 0.1 ml increment trigger
- Safe and easy needle change out via luer lock connection
- Limited spare parts for easy service
- Boilable



## Included in delivery

HSW HENKE-JECT® TBC complete:  
1 x Syringe



## Version

Luer Lock

## Vol/ml

2 ml

## Item no.

2118000080



## Accessories

HSW-ECO® Needle/

0,7 x 4 mm 22 G x 1/8"

## Item no.

8021070046



# HSW MICRO-MATIC®

0,025 ml / 0,05 ml / 0,1 ml

Automatic self-filling syringe for micro-injections

- Exact dosage of smallest injection quantities (0.025 ml / 0.05 ml / 0.1 ml)
- Designed for single or dual injection via one needle
- Optimized for high hand comfort administering low dose injections
- High-strength materials
- Long service life and salt water resistant
- Mechanical counter 0 – 999.999 (automatic reset afterwards)



#### Included in delivery (Double)

- 1 x Syringe incl. mechanical counter
- 2 x Silicone tubing 1,5 m
- 1 x Spare parts set
- 1 x Needle Guard

#### Included in delivery (Single)

- 1 x Syringe incl. mechanical counter
- 1 x Silicone tubing 1,5 m
- 1 x Spare parts set
- 1 x Needle Guard

HSW MICRO-MATIC® Double  
 HSW MICRO-MATIC® Double  
 HSW MICRO-MATIC® Double  
 HSW MICRO-MATIC® Double  
 HSW MICRO-MATIC® Single  
 HSW MICRO-MATIC® Single

0,05 / 0,025 ml	8300054350
0,05 / 0,05 ml	8300054349
0,1 / 0,05 ml	8300054347
0,1 / 0,1 ml	8300054348
0,05 ml	8300054345
0,1 ml	8300054346



Double

Single

#### Extra short needle sizes:

HSW-ECO®	0,70 x 3 mm = 22G x 1/8"
HSW-ECO®	0,70 x 4 mm = 22G x 1/8"
HSW-ECO®	0,60 x 3 mm = 23G x 1/8"
HSW-ECO®	0,60 x 4 mm = 23G x 1/8"
HSW-ECO®	0,60 x 5 mm = 23G x 1/5"

Cannulas on page 35



# TU FLEX-MASTER 10

10 ml / 20 ml / 30 ml / 50 ml

VERSION A / B – for easy dosing / for more precision

## VERSION A

- TPX plastic hypodermic adjustable syringe
- Highly visible barrel scale with extended dose increments
- Exchangeable metal Luer Lock nozzle
- Fully boilable design for disinfection
- Individually packaged including spare o-ring parts
- Distinctive retail outer packaging
- Fitting drench nozzle available as accessory

## VERSION B

- Same features & benefits as version A
- Dosage volume indicated on piston rod
- Dosage nut on the piston to lock in the dose



**VERSION A - for easy dosing**





**VERSION B – for more precision**





<b>VERSION A - for easy dosing</b>		<b>Item no.</b>	
Luer Lock	<b>Vol/ml</b>		
	10 ml	8300028713	
	20 ml	8300028716	
	30 ml	8300028719	
50 ml	8300028722		
<b>VERSION B – for more precision</b>		<b>Item no.</b>	
Luer Lock	<b>Vol/ml</b>		
	10 ml	8300028726	
	20 ml	8300028729	
	30 ml	8300028733	
50 ml	8300028736		



# Accessories for self-filling syringes

Accessories		Item no.	
Draw-off caps/	Ø 20 mm white for bottle size 50 / 100 ml	3600000020	
	Ø 30 mm blue for bottle size 250 / 500 ml	3600000030	
	Ø 33 mm green for bottle size/ 500 ml and larger	3600000033	
	set consisting of 3 sizes Ø 20 mm, 30 mm, 33 mm	3600203033	

- Durable
- Easy to use
- Can be used universally for all bottles

Standard basket for medical bottles up to 100 ml		81402799	
Special basket for medical bottles up to 250 ml		8300013288	
Both basket sizes can be screwed on the existing bottle attachment of HSW ECO-MATIC®, HSW SAFE-MATIC® and HSW UNI-MATIC®. Please note that 250 ml bottles only fit with max. neck diameter of 20 mm.			
Nozzle for use as „mini-drencher“/ Luer Lock			
Luer Lock	11,4 cm	3600095605	
Luer Lock	5,5 cm	8300015882	
The tube attachment can be screwed on each syringe with Luer Lock, independently from the syringe model. Thus every injection syringe can be used as a drench syringe or for oral use.			



# HSW Extensions

Accessories for veterinary syringes

- For a comfortable injection
- For all HSW syringes
- Allows longer distance to the animal, enhanced user safety
- Durable but flexible design
- Safe and stable needle connection
- Residual volume < 2,8 ml
- Length 29 cm (11.5 inch)



Accessories	Item no.		
Flexible extensions for all injection syringes Luer Lock – Luer Lock	29 cm	3099000030	
Fixed extension for HSW ROUX-REVOLVER® 30 ml / Fixed extension for HSW ROUX-REVOLVER® 50 ml /	57 cm	3099000238	
HSW injection tube for all LL injection syringes Luer Lock - Luer Lock	75 cm	8300051939	

# HSW Injection bar

61 cm / 102 cm

Accessories for veterinary syringes

- For a comfortable injection
- For use with all syringes
- Ideal for mass vaccination
- Allows longer distance to the animal, enhanced user safety
- Durable and robust carbon-metal design less weight but strong durability
- Safe and stable needle fitting
- Bend protection for tubing
- Long lasting, wear-free
- Ergonomic handling
- Optimized residual volume



<b>Included in delivery</b>			
1 HSW injection bar incl. tube and bend protection			
<b>Version</b>	<b>Working length</b>	<b>Total length</b>	<b>Item no.</b>
long	83 cm	102 cm	8300014114
short	43 cm	61 cm	8300014428
<b>HSW disinfection container</b>			Item no.
<ul style="list-style-type: none"> <li>- disinfection of the injection bars directly in the field or in the stable</li> <li>- ideal for mass vaccination</li> <li>- also suitable for storage and transportation</li> <li>- for up to two injection bars</li> </ul>			
HSW disinfection container		3,5 l	8300015849

# DRENCHERS

- HSW ECO-MATIC<sup>®</sup> Drencher
- HSW DRENCH-MATIC<sup>®</sup>
- HSW ECO-MATIC<sup>®</sup> with threaded bottle adapter
- TU FLEX-MASTER
- Accessories / Nozzles

# HSW ECO-MATIC<sup>®</sup> Drencher

12,5 ml / 30 ml / 70 ml

Automatic self-filling syringe for oral application

- Especially designed for sheep and cattle or multiple dosing of livestock, optionally available as injector
- Ergonomic and user-friendly design
- High-strength materials guarantee continuous use as well as long service life at low weight
- Dosing wheel for setting the required dosage
- Expansion of our renowned product line of HSW ECO-MATIC<sup>®</sup> syringes



## Included in delivery

HSW ECO-MATIC<sup>®</sup> Drencher complete:

- 1 x Syringe
- 1 x Tubing
- 1 x Drench nozzle 11 cm

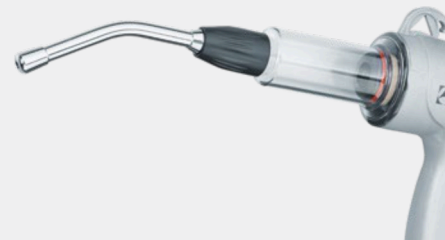

## Version

## Vol/ml

## Item no.

Drencher	12,5 ml (0,5 - 12,5 ml)	8300017257
	30 ml ( 5 - 30 ml)	8300026525
	70 ml (7,5 - 70 ml)	8300029836



Different nozzle attachments are available depending on the application needs.

# HSW DRENCH-MATIC®



10 ml / 23 ml / 30 ml

Automatic self-filling syringe for oral application

- Automatic self-filling syringe for the administration of solutions and suspensions for oral and pour-on use
- Can also be used for injections
- Pressure cast aluminium handle high strength at low weight
- Easy to use and easy to clean
- High strength plastic barrel
- Dosage continuously adjustable
- Dosing accuracy: tolerance < 1 % of dose
- Smooth handle tension adjuster
- Innovative and ergonomic design
- Automatic lubrication due to twin o-ring

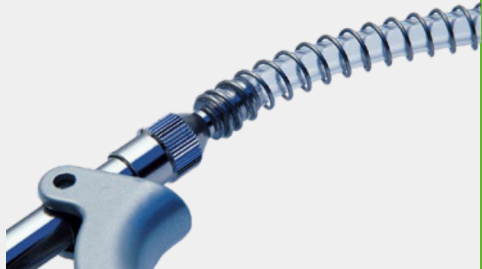

available separately

<p>Included in delivery</p> <p>HSW DRENCH-MATIC® complete:</p> <p>1 x Syringe</p> <p>1 x Tubing</p> <p>1 x Drench nozzle 11 cm</p>		
<p>Version</p> <p>Modelo</p> <p>Drencher</p>	<p>Vol/ml</p> <p>10 ml</p> <p>23 ml</p> <p>30 ml</p>	<p>Item no.</p> <p>3610000550</p> <p>3623000550</p> <p>3030000550*</p>  <p>30 ml</p>
<p>* The product corresponds to separate illustration (older model).</p>		

# HSW ECO-MATIC®

1 ml / 2 ml / 5 ml

Automatic self-filling syringe with threaded bottle adapter for oral application

- Compact bottle mount drencher
- Durable, metal Luer Lock fitting
- Accurate, continuously variable dose setting
- Exceptional in price and performance
- Ergonomic design for ease of use
- Secure bottle fitting
- Attaches to 28 mm threaded bottles



Nozzles are available separately, see accessories (p. 29)

## Included in delivery

HSW ECO-MATIC® complete:  
1 x Syringe  
1 x Threaded bottle adapter

Version Modelo	Vol/ml	Item no.
Luer Lock	1 ml	8300018607
	2 ml	8300015213
	5 ml	8300018605



Threaded bottles available in different sizes:

Version	Vol/ml	Item no.
Plastic bottle	100 ml	8300019266
	250 ml	8300019267
	500 ml	8300017875
Lid sold separately /		8300017876



# TU FLEX-MASTER

10 ml / 20 ml / 30 ml / 50 ml

VERSION A / B – for easy dosing / for more precision

## VERSION A

- TPX plastic hypodermic adjustable syringe
- Highly visible barrel scale with extended dose increments
- Exchangeable metal Luer Lock nozzle
- Fully boilable design for disinfection
- Individually packaged including spare o-ring parts
- Distinctive retail outer packaging
- Fitting drench nozzle available as accessory

## VERSION B

- Same features & benefits as version A
- Dosage volume indicated on piston rod
- Dosage nut on the piston to lock in the dose



VERSION A - for easy dosing



VERSION B – for more precision



<p><b>VERSION A - for easy dosing</b></p> <p>Luer Lock</p>	<p><b>Item no.</b></p> <p>Vol/ml</p> <p>10 ml 8300028713</p> <p>20 ml 8300028716</p> <p>30 ml 8300028719</p> <p>50 ml 8300028722</p>	
<p><b>VERSION B – for more precision</b></p> <p>Luer Lock</p>	<p><b>Item no.</b></p> <p>10 ml 8300028726</p> <p>20 ml 8300028729</p> <p>30 ml 8300028733</p> <p>50 ml 8300028736</p>	
<p><b>Accessories</b></p> <p>Nozzle TU FLEX-MASTER A / B (Can be screwed on)</p>	<p><b>Item no.</b></p> <p>10 cm 8300027273</p>	



# Accessories for Drenchers

For oral application

Accessories		Item no.
Plastic backpack /	2,5 l 5 l	8300001333 8300001334
Set consisting of bag pack, funnel, Carrying strap, closing caps with and without tubing attachment.		
Tubing adapter /	10 on 6 mm 6 on 4 mm	8300020832 8300012173
Nozzle Luer Lock	5,5 cm 11,4 cm	8300015882 3600095605

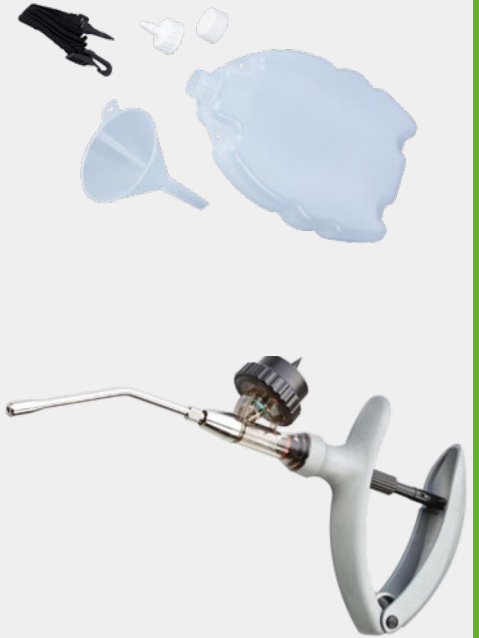

Accessories for HSW ECO-MATIC® Drencher and HSW DRENCH-MATIC®		
Nozzle	11 cm 14 cm	3600003605* 3600005605*
Nozzle (curved)	30 cm 46 cm	8300041981* 8300041982*
Luer Lock attachment (not shown) /		3600030619*
Nozzle (curved) with handle /	46 cm	8300041983*

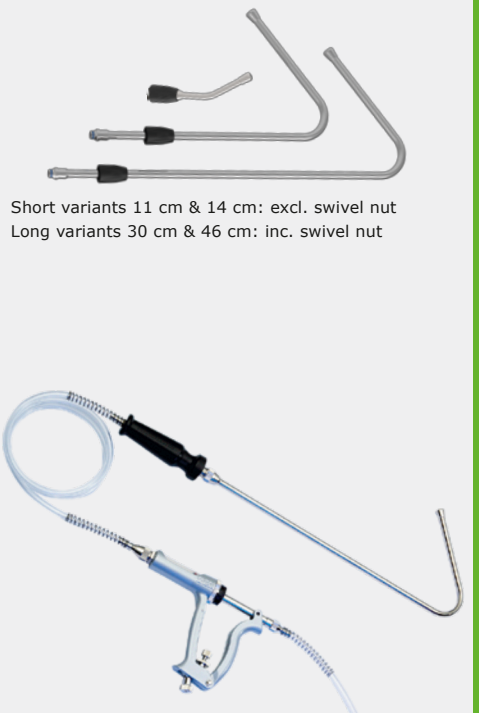

Short variants 11 cm & 14 cm: excl. swivel nut  
Long variants 30 cm & 46 cm: inc. swivel nut

- For a comfortable application and enlarged distance to the animal
- Stable metal design
- Enhanced user-safety

\*These positions are only suitable for HSW DRENCH-MATIC® 10 ml and 23 ml as well as HSW ECO-MATIC® Drencher 12.5 ml and 30 ml.

# POUR ON APPLICATORS

- HSW ECO-MATIC<sup>®</sup> Pour On
- DRENCH-MATIC<sup>®</sup>
- Accessories / Nozzles

# HSW ECO-MATIC® Pour On

12,5 ml / 30 ml / 70 ml

Automatic self-filling syringe for Pour On applications

- Especially designed for sheep and cattle, optionally available as injector
- Ergonomic and user-friendly design
- High-strength materials guarantee continuous use as well as long service life
- Very high strength in combination with low weight
- Expansion of our renowned product line of HSW ECO-MATIC® syringes
- Dosing wheel for setting the required dosage



## Included in delivery

HSW ECO-MATIC® Pour On complete:

- 1 x Syringe
- 1 x Tubing
- 1 x Nozzle with shower head

## Version

## Vol/ml

## Item no.

Pour On	12,5 ml (0,5 - 12,5 ml)	8300017257*
	30 ml ( 5 - 30 ml)	8300017235
	70 ml (7,5 - 70 ml)	8300018738

\*Only with metal pipe



Different front parts adaptable depending on application. (See p. 33)

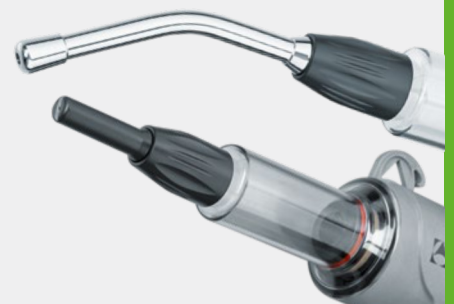

# HSW DRENCH-MATIC®

10 ml/23 ml/30 ml

Automatic self-filling syringe for oral application

- Automatic self-filling syringe for the administration of solutions and suspensions for oral and pour-on use
- Can also be used for injections
- Pressure cast aluminium handle - high strength at low weight
- Easy to use and easy to clean
- High strength plastic barrel
- Dosing accuracy: tolerance < 1 % of dose
- Drenching pressure smoothly adjustable
- Innovative and ergonomic design
- Automatic lubrication due to twin o-ring



available seperately

## Included in delivery

HSW DRENCH-MATIC® complete:  
 1 x Seringe  
 1 x Tubing  
 1 x Drench nozzle 11 cm

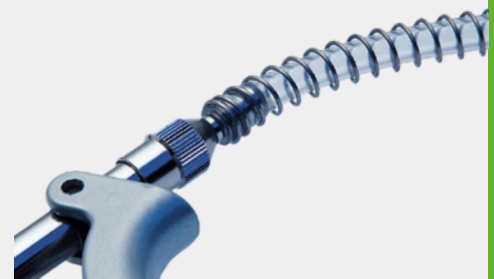

## Version

## Vol/ml

## Item no.

10 ml	3610000550
23 ml	3623000550
30 ml	3030000550*



30 ml

\* The product corresponds to separate illustration (older model).

# Accessories for Pour On Applicators

For Pour On application

Accessories		Item no.	
Plastic backpack /	2,5 l 5 l	8300001333 8300001334	
Set consisting of backpack, funnel, carrying strap, closing cap and draw-off cap.			
Hose adapter /	10 on 6 mm 6 on 4 mm	8300020832 8300012173	
Accessories		Item no.	
Nozzles for 12,5 ml - 30 ml			
Nozzle curved (metal) /	11 cm	3600003605	
Nozzle curved (metal) /	14 cm	3600005605	
Nozzle curved (plastic) /		8300016387	
Nozzle straight (plastic) /		8300030096	
Nozzle straight (metal) /		8300006381	
Nozzles for	70 ml		
Nozzle curved (metal) /	15 cm	8300029848	
Nozzle curved (plastic) /		8300029850	
			<p data-bbox="1043 1733 1214 1760">excl. swivel nut</p>

# NEEDLES AND SINGLE-USE SYRINGES

- HSW-ECO<sup>®</sup>
- HSW-PREMIUM<sup>®</sup>
- HSW HENKE-JECT<sup>®</sup>

# HSW-ECO®

Reusable veterinary needles



- Impressive price-performance ratio
- Generously-shaped metal attachments
- Attachments are marked with mm and gauge information
- Label features an ISO colour-code for quick identification of diameter
- Packaging: 12 items per case, 144 per box

## Reusable needles (Luer Lock)

Dimensions	Colour-code	Item no.	Dimensions	Colour-code	Item no.
0,60 x 3 mm 23 G x 1/8"	03/06	8300042354	1,40 x 25 mm 17 G x 1"	25/14	8021140256
0,60 x 4 mm 23 G x 1/8"	04/06	8300042357	1,40 x 35 mm 17 G x 1 3/8"	35/14	8021140356
0,60 x 5 mm 23 G x 3/16"	05/06	8300042360	1,40 x 40 mm 17 G x 1 1/2"	40/14	8021140406
0,70 x 3 mm 22 G x 1/8"	03/07	8300042363	1,50 x 50 mm -	50/15	8021150506
0,70 x 4 mm 22 G x 1/8"	04/07	8300042366	1,50 x 15 mm -	15/15	8021150156
0,70 x 10 mm 22 G x 3/8"	10/07	8300042369	1,50 x 20 mm -	20/15	8021150206
0,70 x 14 mm 22 G x 1/2"	14/07	8300042375	1,50 x 25 mm -	25/15	8021150256
0,70 x 15 mm 22 G x 5/8"	15/07	8300041780	1,50 x 30 mm -	30/15	8021150306
0,60 x 3 mm 23 G x 1/8"	03/06	8300019577	1,50 x 35 mm -	35/15	8021150356
0,60 x 4 mm 23 G x 1/8"	04/06	8300019578	1,50 x 40 mm -	40/15	8021150406
0,60 x 5 mm 23 G x 3/16"	05/06	8300019579	1,60 x 6 mm 16 G x 1/4"	06/16	8300017687
0,70 x 3 mm 22 G x 1/8"	03/07	8300019576	1,60 x 10 mm 16 G x 3/8"	10/16	8300000697
0,70 x 4 mm 22 G x 1/8"	04/07	8021070046	1,60 x 13 mm 16 G x 1/2"	13/16	8300017686
0,70 x 10 mm 22 G x 3/8"	10/07	8021070106	1,60 x 15 mm 16 G x 5/8"	15/16	8021160156
0,70 x 13 mm 22 G x 1/2"	13/07	8300039032	1,60 x 20 mm 16 G x 3/4"	20/16	8021160206
0,80 x 5 mm 21 G x 3/16"	05/08	8300011504	1,60 x 25 mm 16 G x 1"	25/16	8021160256
0,80 x 10 mm 21 G x 3/8"	10/08	8021080106	1,60 x 30 mm 16 G x 1 1/4"	30/16	8021160306
0,80 x 15 mm 21 G x 5/8"	15/08	8021080156	1,60 x 35 mm 16 G x 1 3/8"	35/16	8021160356
0,80 x 25 mm 21 G x 1"	25/08	8300011505	1,60 x 40 mm 16 G x 1 1/2"	40/16	8021160406
0,90 x 6 mm 20 G x 1/4"	06/09	8300017682	1,80 x 13 mm 15 G x 1/2"	13/18	8300017688
0,90 x 10 mm 20 G x 3/8"	10/09	8021090106	1,80 x 15 mm 15 G x 5/8"	15/18	8021180156
0,90 x 13 mm 20 G x 1/2"	13/09	8300017681	1,80 x 20 mm 15 G x 3/4"	20/18	8021180206
0,90 x 15 mm 20 G x 5/8"	15/09	8021090156	1,80 x 25 mm 15 G x 1"	25/18	8021180256
1,00 x 10 mm 19 G x 3/8"	10/10	8021100106	1,80 x 30 mm 15 G x 1 1/4"	30/18	8021180306
1,00 x 13 mm 19 G x 1/2"	13/10	8300017683	1,80 x 35 mm 15 G x 1 3/8"	35/18	8021180356
1,00 x 15 mm 19 G x 5/8"	15/10	8021100156	1,80 x 40 mm 15 G x 1 1/2"	40/18	8021180406
1,00 x 20 mm 19 G x 3/4"	20/10	8021100206	1,80 x 45 mm 15 G x 1 3/4"	45/18	8021180456
1,00 x 25 mm 19 G x 1"	25/10	8021100256	2,00 x 13 mm 14 G x 1/2"	13/20	8300017689
1,00 x 30 mm 19 G x 1 1/4"	30/10	8021100306	2,00 x 15 mm 14 G x 5/8"	15/20	8021200156
1,20 x 10 mm 18 G x 3/8"	10/12	8021120106	2,00 x 20 mm 14 G x 3/4"	20/20	8021200206
1,20 x 13 mm 18 G x 1/2"	13/12	8300017684	2,00 x 25 mm 14 G x 1"	25/20	8021200256
1,20 x 15 mm 18 G x 5/8"	15/12	8021120156	2,00 x 30 mm 14 G x 1 1/4"	30/20	8021200306
1,20 x 20 mm 18 G x 3/4"	20/12	8021120206	2,00 x 35 mm 14 G x 1 3/8"	35/20	8021200356
1,20 x 25 mm 18 G x 1"	25/12	8021120256	2,00 x 40 mm 14 G x 1 1/2"	40/20	8021200406
1,20 x 30 mm 18 G x 1 1/4"	30/12	8021120306	2,00 x 45 mm 14 G x 1 3/4"	45/20	8021200456
1,20 x 40 mm 18 G x 1 1/2"	40/12	8021120406	2,00 x 50 mm 14 G x 2"	50/20	8021200506
1,30 x 15 mm -	15/13	8021130156	2,20 x 15 mm -	15/22	8300000700
1,30 x 20 mm -	20/13	8021130206	2,20 x 20 mm -	20/22	8021220206
1,40 x 10 mm 17 G x 3/8"	10/14	8021140106	2,20 x 25 mm -	25/22	8021220256
1,40 x 13 mm 17 G x 1/2"	13/14	8300017685	2,20 x 30 mm -	30/22	8021220306
1,40 x 15 mm 17 G x 5/8"	15/14	8021140156	2,20 x 35 mm -	35/22	8021220356
1,40 x 20 mm 17 G x 3/4"	20/14	8021140206	2,40 x 35 mm 13 G x 1 3/8"	35/24	8021240356





# HSW-PREMIUM®

Reusable veterinary needles



- Distinctive bison bevel for long service life
- Tube made of spring-grade drawn chrome-nickel stainless steel
- Thick-walled needle tube with exceptional stability and elasticity
- Generously-shaped metal attachments
- Attachments are marked with mm and gauge information
- Direct removal from transparent container ensures reduced risk of injury and contamination
- Label features an ISO colour-code for quick identification of diameter
- Packaging: 10 items per case, 100 per box

## Reusable needles (Luer Lock)

Dimensions	Colour-code	Item no.	Dimensions	Colour-code	Item no.
0,80 x 10 mm 21 G x 3/8" 10/08		3221080106*	2,00 x 40 mm 14 G x 1 1/2" 40/20		3221200406*
0,90 x 10 mm 20 G x 3/8" 10/09		3221090106*	2,00 x 50 mm 14 G x 2" 50/20		3221200506**
0,90 x 15 mm 20 G x 5/8" 15/09		3221090156*	2,20 x 25 mm - 25/22		3221220256*
1,00 x 10 mm 19 G x 3/8" 10/10		3221100106	2,20 x 30 mm - 30/22		3221220306*
1,00 x 15 mm 19 G x 5/8" 15/10		3221100156	2,20 x 35 mm - 35/22		3221220356*
1,00 x 20 mm 19 G x 3/4" 20/10		3221100206	2,40 x 25 mm 13G x 1" 25/24		3221240256*
1,00 x 25 mm 19 G x 1" 25/10		3221100256*	2,40 x 30 mm 13G x 1 1/4" 30/24		3221240306*
1,20 x 10 mm 18 G x 3/8" 10/12		3221120106*			
1,20 x 15 mm 18 G x 5/8" 15/12		3221120156			
1,20 x 20 mm 18 G x 3/4" 20/12		3221120206			
1,20 x 25 mm 18 G x 1" 25/12		3221120256			
1,20 x 35 mm 18 G x 1 3/8" 35/12		3221120356*			
1,40 x 10 mm 17 G x 3/8" 10/14		3221140106*			
1,40 x 15 mm 17 G x 5/8" 15/14		3221140156			
1,40 x 20 mm 17 G x 3/4" 20/14		3221140206			
1,40 x 25 mm 17 G x 1" 25/14		3221140256			
1,40 x 30 mm 17 G x 1 1/4" 30/14		3221140306*			
1,40 x 35 mm 17 G x 1 3/8" 35/14		3221140356			
1,60 x 10 mm 16 G x 3/8" 10/16		3221160106*			
1,60 x 15 mm 16 G x 5/8" 15/16		3221160156			
1,60 x 20 mm 16 G x 3/4" 20/16		3221160206			
1,60 x 25 mm 16 G x 1" 25/16		3221160256			
1,60 x 30 mm 16 G x 1 1/4" 30/16		3221160306*			
1,60 x 35 mm 16 G x 1 3/8" 35/16		3221160356			
1,60 x 100 mm 16 G x 4" 100/16		3221161006**			
1,80 x 15 mm 15 G x 5/8" 15/18		3221180156			
1,80 x 20 mm 15 G x 3/4" 20/18		3221180206			
1,80 x 25 mm 15 G x 1" 25/18		3221180256			
1,80 x 30 mm 15 G x 1 1/4" 30/18		3221180306*			
1,80 x 35 mm 15 G x 1 3/8" 35/18		3221180356			
1,80 x 40 mm 15 G x 1 1/2" 40/18		3221180406*			
2,00 x 15 mm 14 G x 5/8" 15/20		3221200156*			
2,00 x 20 mm 14 G x 3/4" 20/20		3221200206			
2,00 x 25 mm 14 G x 1" 25/20		3221200256			
2,00 x 30 mm 14 G x 1 1/4" 30/20		3221200306*			
2,00 x 35 mm 14 G x 1 3/8" 35/20		3221200356			

## Reusable needles (thread)

Dimensions	Colour-code	Item no.
1,00 x 10 mm 19 G x 3/8" 10/10		3225100106
1,00 x 15 mm 19 G x 5/8" 15/10		3225100156
1,00 x 20 mm 19 G x 3/4" 20/10		3225100206
1,20 x 15 mm 18 G x 5/8" 15/12		3225120156
1,20 x 20 mm 18 G x 3/4" 20/12		3225120206
1,20 x 25 mm 18 G x 1" 25/12		3225120256
1,40 x 15 mm 17 G x 5/8" 15/14		3225140156
1,40 x 20 mm 17 G x 3/4" 20/14		3225140206
1,40 x 25 mm 17 G x 1" 25/14		3225140256
1,40 x 35 mm 17 G x 1 3/8" 35/14		3225140356
1,60 x 15 mm 16 G x 5/8" 15/16		3225160156
1,60 x 20 mm 16 G x 3/4" 20/16		3225160206
1,60 x 25 mm 16 G x 1" 25/16		3225160256
1,60 x 35 mm 16 G x 1 3/8" 35/16		3225160356
1,80 x 15 mm 15 G x 5/8" 15/18		3225180156
1,80 x 20 mm 15 G x 3/4" 20/18		3225180206
1,80 x 25 mm 15 G x 1" 25/18		3225180256
1,80 x 35 mm 15 G x 1 3/8" 35/18		3225180356
2,00 x 20 mm 14 G x 3/4" 20/20		3225200206
2,00 x 25 mm 14 G x 1" 25/20		3225200256
2,00 x 35 mm 14 G x 1 3/8" 35/20		3225200356
2,20 x 35 mm - 35/22		8300001897



\* Special sizes – please note minimum order volume.

\*\* Separate packaging because of special length

# HSW HENKE-JECT®

Single-use needles



- Exceptional quality, similar to human design
- ISO 9626 stainless steel
- Available with long or short bevel
- Transparent polypropylene hub
- Protective cap of polypropylene
- Siliconized needle tube, primarily thin-walled
- Sterile, pyrogen-free and non-toxic
- 5-year shelf life for sterile goods

Standard programme for available HSW HENKE-JECT® single-use needles/

Dimensions	Colour-code	Item no.	Dimensions	Colour-code	Item no.
0,30 x 12 mm 30G x 1/2" 12/03		4710003012	0,90 x 40 mm 20 G x 1 1/2" 40/09		4710009040
0,40 x 12 mm 27G x 1/2" 12/04		4710004012	0,90 x 50 mm 20 G x 2" 50/09		4710009050
0,40 x 20 mm 27G x 3/4" 20/04		4710004020	1,10 x 25 mm 19 G x 1" 25/11		4710011025
0,45 x 12 mm 26G x 1/2" -/-		4710004512	1,10 x 30 mm 19 G x 1 1/4" 30/11		4710011030
0,45 x 25 mm 26G x 1" -/-		4710004525	1,10 x 40 mm 19 G x 1 1/2" 40/11		4710011040
0,50 x 16 mm 25G x 5/8" 16/05		4710005016	1,10 x 50 mm 19 G x 2" 50/11		4710011050
0,50 x 25 mm 25 G x 1" 25/05		4710005025	1,20 x 6 mm 18 G x 1/4" 06/12		8300018621
0,55 x 25 mm 24G x 1" -/-		4710005525	1,20 x 12 mm 18 G x 1/2" 12/12		8300018619
0,60 x 25 mm 23G x 1" 25/06		4710006025	1,20 x 25 mm 18 G x 1" 25/12		4710012025
0,60 x 30 mm 23G x 1 1/4" 30/06		4710006030	1,20 x 30 mm 18 G x 1 1/4" 30/12		4710012030
0,70 x 10 mm 22G x 3/8" 10/07		8300018624	1,20 x 40 mm 18 G x 1 1/2" 40/12		4710012040
0,70 x 25 mm 22G x 1" 25/07		4710007025	1,20 x 50 mm 18 G x 2" 50/12		4710012050
0,70 x 30 mm 22G x 1 1/4" 30/07		4710007030	1,40 x 20 mm 17 G x 3/4" 20/14		8300010234
0,70 x 40 mm 22G x 1 1/2" 40/07		4710007040	1,40 x 50 mm 17 G x 2" 50/14		4710015050
0,80 x 10 mm 21G x 3/8" 10/08		8300014301	1,60 x 12 mm 16 G x 1/2" 12/16		8300018620
0,80 x 16 mm 21G x 5/8" 16/08		4710008016	1,60 x 25 mm 16 G x 1" 25/16		4710016025
0,80 x 25 mm 21G x 1" 25/08		4710008025	1,60 x 40 mm 16 G x 1 1/2" 40/16		4710016040
0,80 x 40 mm 21G x 1 1/2" 50/08		4710008040	1,65 x 25 mm 16 G x 1" -/-		8300021963
0,80 x 50 mm 21G x 2" 50/08		4710008050	1,80 x 40 mm 15 G x 1 1/2" 40/18		4710018040
0,90 x 6 mm 20G x 1/4" 06/09		8300018622	1,80 x 50 mm 15 G x 2" 50/18		4710018050
0,90 x 12 mm 20G x 1/2" 12/09		8300018623	2,10 x 40 mm 14 G x 1 1/2" 40/21		8300013707
0,90 x 16 mm 20G x 5/8" 16/09		8300010721	2,10 x 60 mm 14 G x 2 1/2" 60/21		8300021960
0,90 x 25 mm 20G x 1" 25/09		4710009025	2,10 x 80 mm 14 G x 3" 80/21		8300021961
0,90 x 30 mm 20G x 1 1/4" 30/09		4710009030			

Other needle sizes available upon request

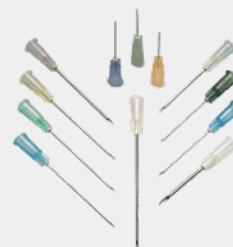

# HSW HENKE-JECT®

Single-use syringes

- Exceptional quality, similar to human design
- Sterile, individual blister packaging
- Pyrogen-free, PVC-free, non-toxic
- Smudge-proof scale and transparent barrel
- Environmentally friendly packaging
- All sterile products are also available in non-sterile version (bulk) upon request



Standard programme of available **HSW HENKE-JECT®**  
**two-part** single-use syringes

Vol/ ml		Item no.
<b>2 part without needle</b>		
1 ml	TBC*	4010.200V0
1 ml	Ins. 40IU**	4010.100V0
2 ml	(3 ml)	4020.000V0
2 ml	(3 ml) Luer Lock	4020.X00V0
5 ml	(6 ml)	4050.000V0
5 ml	(6 ml) Luer Lock	4050.X00V0
10 ml	(12 ml)	4100.000V0
10 ml	(12 ml) Luer Lock	4100.X00V0
20 ml	(24 ml)	4200.000V0
20 ml	(24 ml) Luer Lock	4200.X00V0
<b>2 part with by-packed needle</b>		
2 ml	(3 ml) 23 G x 1 1/4"	4022L000V0
5 ml	(6 ml) 21 G x 1 1/2"	4052D000V0
5 ml	(6 ml) 22 G x 1 1/4"	4052K000V0
10 ml	(12 ml) 21 G x 1 1/2"	4102D000V0
20 ml	(24 ml) 21 G x 1 1/2"	4202D000V0

\* with ml-grading

\*\*with insulin grading

All syringe sizes are available with luer slip tip as standard.  
All syringes (except of some 1 ml versions) can be supplied with luer lock tip upon request.

Standard programme of available **HSW HENKE-JECT®**  
**three-part** single-use syringes

Vol/ ml		Item no.
<b>3 part without needle</b>		
1 ml	TBC*	5010.200V0
1 ml	Low Dead Space Luer	8300014579
1 ml	Low Dead Space Luer Lock	8300018745
1 ml	Ins. 40IU**	5010.100V0
2 ml	(2,5 ml)	5020.000V0
3 ml		8300005761
3 ml	Luer Lock	8300005762
5 ml	(6 ml)	5050.000V0
5 ml	(6 ml) Luer Lock	5050.X00V0
10 ml	(12 ml)	5100.000V0
10 ml	(12 ml) Luer Lock	5100.X00V0
20 ml	(24 ml)	5200.000V0
20 ml	(24 ml) Luer Lock	5200.X00V0
30 ml	(36 ml) Luer	5300.000D0
30 ml	(36 ml) Luer Lock	5300.X00D0
50 ml	(60 ml) Luer	8300006680
50 ml	(60 ml) Luer Lock	8300006682
50 ml	(60 ml) Katheter / cath.	830000668
100 ml	(120 ml) Katheter / cath.	8300005458
<b>3 part with by-packed needle</b>		
2 ml	(2,5 ml) 23 G x 1 1/4"	5022L000V0
2 ml	(3 ml) 22 G x 3/4"	5042G000V0
5 ml	(6 ml) 18 G x 1 1/2"	5052Z000V0
5 ml	(6 ml) 22 G x 1 1/2"	5052D000V0
5 ml	(6 ml) 21 G x 1 1/4"	5052K000V0
10 ml	(12 ml) 21 G x 1 1/2"	5102D000V0
10 ml	(12 ml) 22 G x 1 1/4"	5102K000V0
20 ml	(24 ml) 21 G x 1 1/2"	5202H000V0
20 ml	(24 ml) 20 G x 1 1/2"	5202D000V0
20 ml	(24 ml) 18 G x 1 1/2"	5202Z000V0

In the case of syringes with by-packed needles, further syringe-needle combinations are also available upon request.



# HSW HENKE-JECT®

## Insulin syringes























0,5 ml / 1 ml









- Crystal clear cylinder with easy to read scale
- Piston, piston-rod and cylinder consisting of Polypropylene
- With integrated needle
- Free of Pyrogene and PVC
- Free of Latex
- Non-toxic
- Certified acc. to ISO 9626 / Amd 1:2001 and ISO 8537:2007
- Double o-ring for additional security







Version	Vol/ml	Item no.	
0,5ml INS 40IU 29Gx1/2"	0,5 ml	8300034658	
1ml INS 40IU 29Gx1/2"	1 ml	8300034660	
<p>Syringes of size 0.5 ml are delivered in a sterile polybag, 10 pcs. each. Syringes of size 1 ml are delivered in a blister packaging.</p>			
			0,5 ml
			1 ml

# Overview of areas of application

Injection systems				
	< 2 ml	2 ml	> 2 ml	Optional accessories
HSW ECO-MATIC® with Bottle Mount Basket	0,3 ml, 0,5 ml, 1 ml 	2 ml 	5 ml 	Extension, nozzles, large basket for 250ml bottles
HSW ECO-MATIC® Bottle Mount Universal Collars	0,3 ml, 0,5 ml, 1 ml 	2 ml 	5 ml 	Extension, nozzles, threaded bottle adapter
HSW ECO-MATIC® tubing version	1 ml 	2 ml 	5 ml, 12,5 ml 	Draw-off caps, extension, nozzles, ascending tubes
HSW ECO-MATIC® TWIN	0,5 ml, 1 ml 	2 ml 		Draw-off caps, threaded bottle adapter, ascending tubes
HSW ROUX-REVOLVER®			10 ml, 30 ml, 50 ml 	Extension, nozzles
HSW MULTI-MATIC®			25 ml, 50 ml 	Extension, nozzles
HSW VET-MATIC®			5 ml, 10 ml 	Draw-off caps, extension, nozzles, ascending tubes
HSW FERRO-MATIC®			3 ml, 5 ml 	Universal bottle collars, extension, threaded bottle adapter
HSW SAFE-MATIC®		2 ml 		Draw-off caps, ascending tubes
HSW UNI-MATIC®	1 ml 	2 ml 	5 ml 	Draw-off caps, extension, nozzles, universal bottle collars, threaded bottle adapter
HSW HENKE-JECT® TBC		2 ml 		HSW-ECO® needle 0,7 x 4mm 22 G x 1/8"
HSW MICRO-MATIC®	0,05 ml, 0,1 ml 			
TU FLEX-MASTER			10 ml, 20 ml, 30 ml, 50 ml 	Nozzles

Drenchers				
	< 20 ml	20-30 ml	> 30 ml	
HSW ECO-MATIC® Drencher	12,5 ml 	30 ml 	70 ml 	Different nozzles, Luer Lock attachment for injections
HSW DRENCH-MATIC®	10 ml 	23 ml, 30 ml 		Different nozzles, Luer Lock attachment for injections
HSW ECO-MATIC® with threaded bottle adapter	1 ml, 2 ml, 5 ml 			Different nozzles with Luer Lock attachment
TU FLEX-MASTER	10 ml 	20 ml, 30 ml 	50 ml 	Nozzles

Pour On Applicators				
	< 20 ml	20-30 ml	> 30 ml	
HSW ECO-MATIC® Pour On	12,5 ml 	30 ml 	70 ml 	Different nozzles: Open stream, fan tip, shower tip
HSW DRENCH-MATIC®	10 ml 	23 ml, 30 ml 		Different nozzles: Open stream, fan tip, shower tip



© copyright · Henke-Sass, Wolf GmbH · 07/2023 · Subject to alterations in technology and design



## Think Livestock

 16 Grevillea Road  
Huntly VIC 3551

 03 5448 8942

 [www.thinklivestock.com](http://www.thinklivestock.com)  
 [info@thinklivestock.com](mailto:info@thinklivestock.com)